

The Atlas Copco logo is positioned in the top right corner of the image. It consists of the company name "Atlas Copco" in a white, serif font, centered between two horizontal white bars. The logo is set against a solid blue rectangular background.

Atlas Copco

A technical drawing overlay is located in the bottom left corner of the image. It features a blue background with white lines representing a mechanical drawing of a circular component. The drawing includes various dimensions and annotations, such as "1380 144.31", "1600 164.21", "300", "Ø170", "Ø172", "Ø174", "Ø176", "Ø178", "Ø180", "Ø182", "Ø184", "Ø186", "Ø188", "Ø190", "Ø192", "Ø194", "Ø196", "Ø198", "Ø200", "Ø202", "Ø204", "Ø206", "Ø208", "Ø210", "Ø212", "Ø214", "Ø216", "Ø218", "Ø220", "Ø222", "Ø224", "Ø226", "Ø228", "Ø230", "Ø232", "Ø234", "Ø236", "Ø238", "Ø240", "Ø242", "Ø244", "Ø246", "Ø248", "Ø250", "Ø252", "Ø254", "Ø256", "Ø258", "Ø260", "Ø262", "Ø264", "Ø266", "Ø268", "Ø270", "Ø272", "Ø274", "Ø276", "Ø278", "Ø280", "Ø282", "Ø284", "Ø286", "Ø288", "Ø290", "Ø292", "Ø294", "Ø296", "Ø298", "Ø300".

Liquid applied sound dampening in paint shops

Atlas Copco's SCA product line provides
LASD solutions for highly productive manufacturing

Meeting highest demands in paint shops

Sealing and sound dampening applications in paint shops require a high level of quality, reliability and precision. They need to prevent corrosion in the long term and meet increasingly high demands in a car's aesthetic appearance and passenger comfort.

Every production line is unique, but paint shops are made up of four main processes

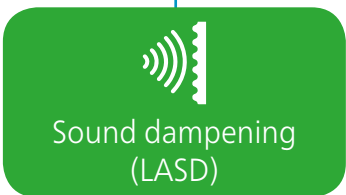
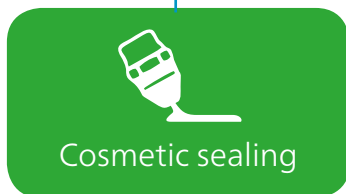
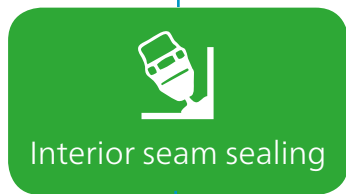
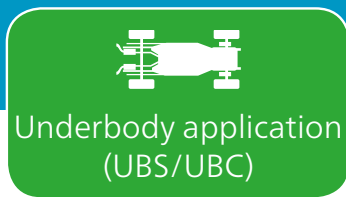

FLAT STREAM

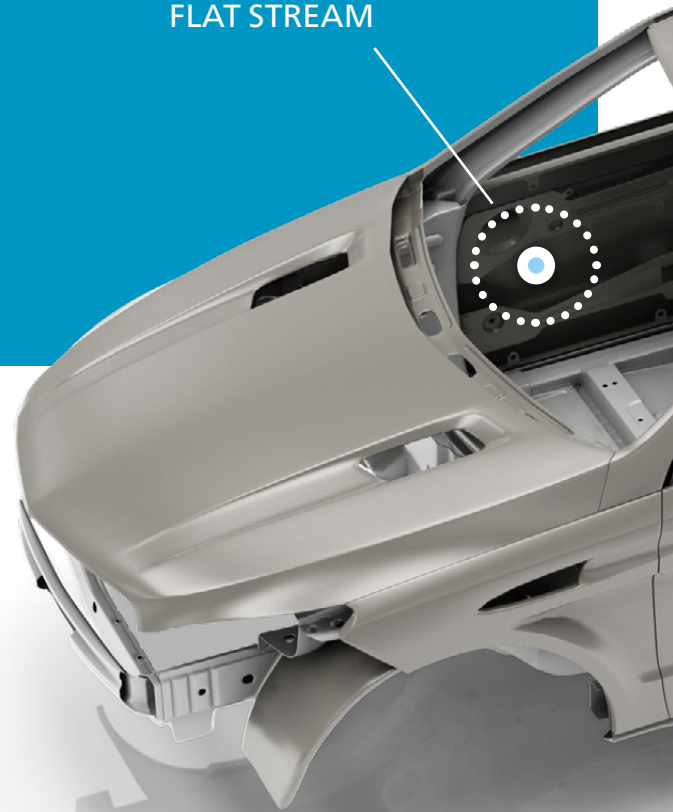

Major challenges

- Effective prevention of humidity and corrosion
- Advanced design and increasingly complex geometries of car parts
- Limited accessibility of sealing areas
- High demands in aesthetics and passenger comfort
- Temperature-sensitive materials

Challenges in LASD

To reduce the noise levels and thereby increase drivers' and passengers' comfort, liquid-applied sound dampening materials (LASD) are often used on the floor panel. Those materials can be challenging, especially when applied in high volumes and flow rates. Robust system components are vital.

Atlas Copco's SCA product line offers high-quality and effective dispensing systems for LASD applications in paint shops. Depending on the customers' requirements and material properties, different applications and system configurations are possible.

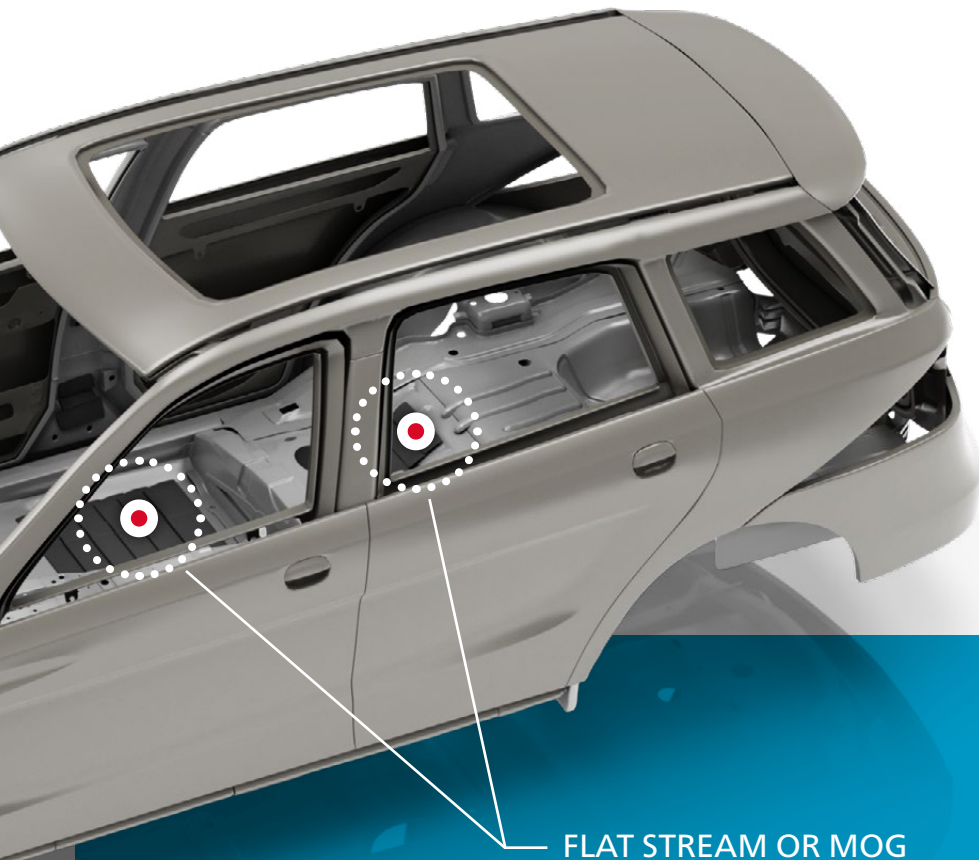

FLAT STREAM OR MOG

Automated SCA dispensing solutions for LASD



Application technologies for LASD

Sound dampening material is most commonly applied by **flat stream** technology or with the **multi-orifice applicator (MOG)**. Both technologies fulfill the demand of this application process. The appropriate choice is dependent on the customers' requirements and preferences based on the used material. In our Atlas Copco Innovation Center we apply LASD material on vibration and noise hotspots to evaluate the optimal application pattern and areas.

LASD flat stream

Flat stream is a **low-pressure** application and most commonly used for LASD. The bead width is defined by the nozzle geometry.

For LASD, a wide slot nozzle is used to enable broad beads and an even material distribution, all while handling high flow rates at short cycle times. Flat stream is a very effective and flexible application for LASD. The liquid material can be applied **exactly where needed**. For example, in hotspot areas more sound dampening material is needed; in areas with low vibrations, material can be saved.

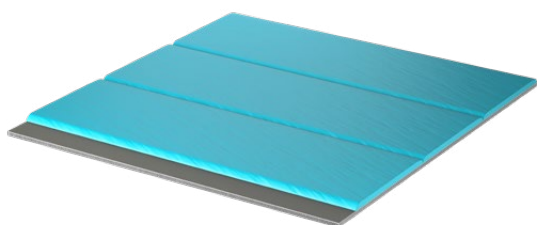
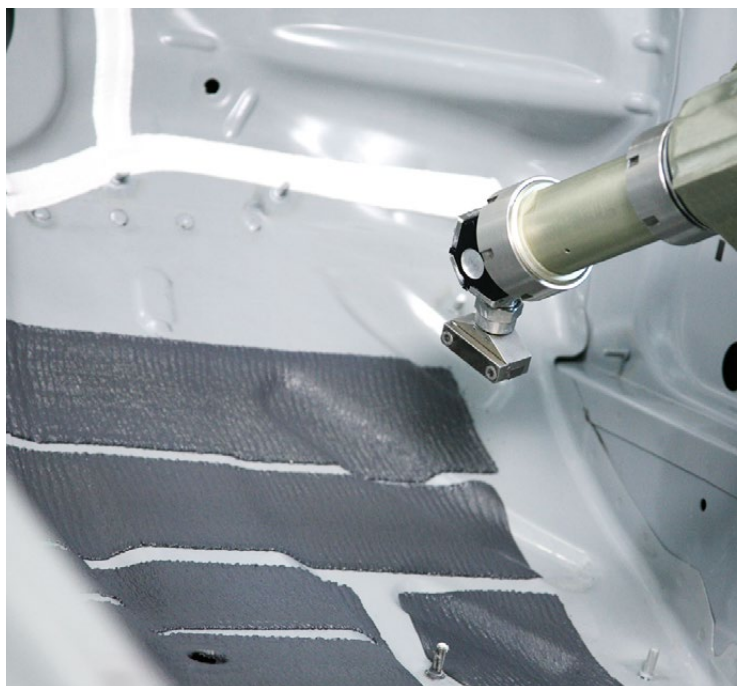

- High flow rates at short application times
- Material can be applied exactly where needed

Technology	Bead width [mm]	Bead thickness [mm]	Material flow [cm ³ /s]	Pressure	Robot speed [mm/s]	Distance to part [mm]	Material	Application temp. [°C]
LASD flat stream	70 – 100	2.2 – 3.9	50 – 100	low	150 – 400	40 – 100	Water based acrylic; rubber	customized

Application parameters for reference use only

MOG

Streaming with a multi-orifice applicator (MOG) is a **simple and effective** solution for applying LASD. It is mainly used for water-based acrylic materials.

The application width can either be 75 mm or 150 mm. Within this width, **multiple single beads** are applied in parallel. High volumes can thus be processed at short cycle times. At the same time, the special bead pattern provides a **large application surface for an improved curing**.

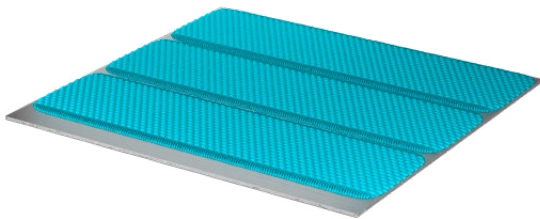
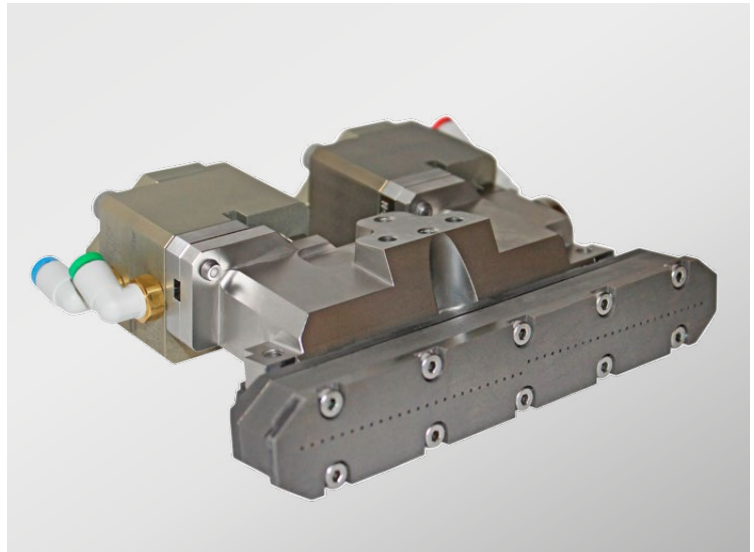

- High volumes at short application times
- Large application surface improves curing of material

Technology	Bead width [mm]	Bead thickness [mm]	Material flow [cm ³ /s]	Pressure	Robot speed [mm/s]	Distance to part [mm]	Material	Application temp. [°C]
MOG	75 or 150	2.2 – 3.9	50 – 100	low	150 – 300	40 – 100	Water based acrylic	customized

Application parameters for reference use only

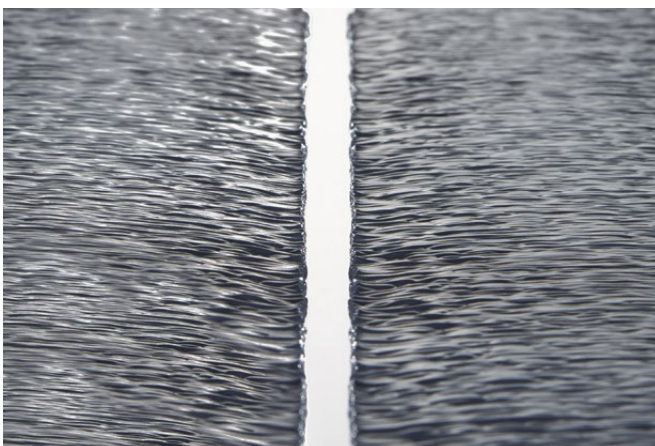

Application with LASD flat stream



Application with MOG

Automated application systems

The SCA product line offers complete automated application systems for LASD. The selection of components and installing the system must focus on the high precision of the application and the typical material properties.

System components

The components for paint shop application systems are developed for high-performance car manufacturing. All parts that are in contact with the material can be made out of stainless steel if the material requires this.



Application control

The SCA system controller **directs all main functions and components of the application**. For easy operation, an integrated HMI and a central, external HMI are available. The connection from the SCA application controller to the robot controller can be realized with all common industrial field bus systems.



Metering systems

The selection of the metering unit is dependent on the customers' requirements for flow, volume, and pressure. SCA metering systems for LASD applications are **optimized for highly abrasive material**.



Heating

To maintain a constant condition independent of the ambient temperature, the **material is often heated** to 32 – 37°C. Therefore the Atlas Copco system can be adapted with heated hoses and heating elements on the meter and valves.



System installation

The high quality requirements for the process determine the choice of the system and the positioning of components. With the [Atlas Copco expertise in system installation](#), we ensure high temperature stability and minimal pressure drops, long lifetimes, and easy maintenance.



Industry-proven components and various options ensure a superior application in every condition

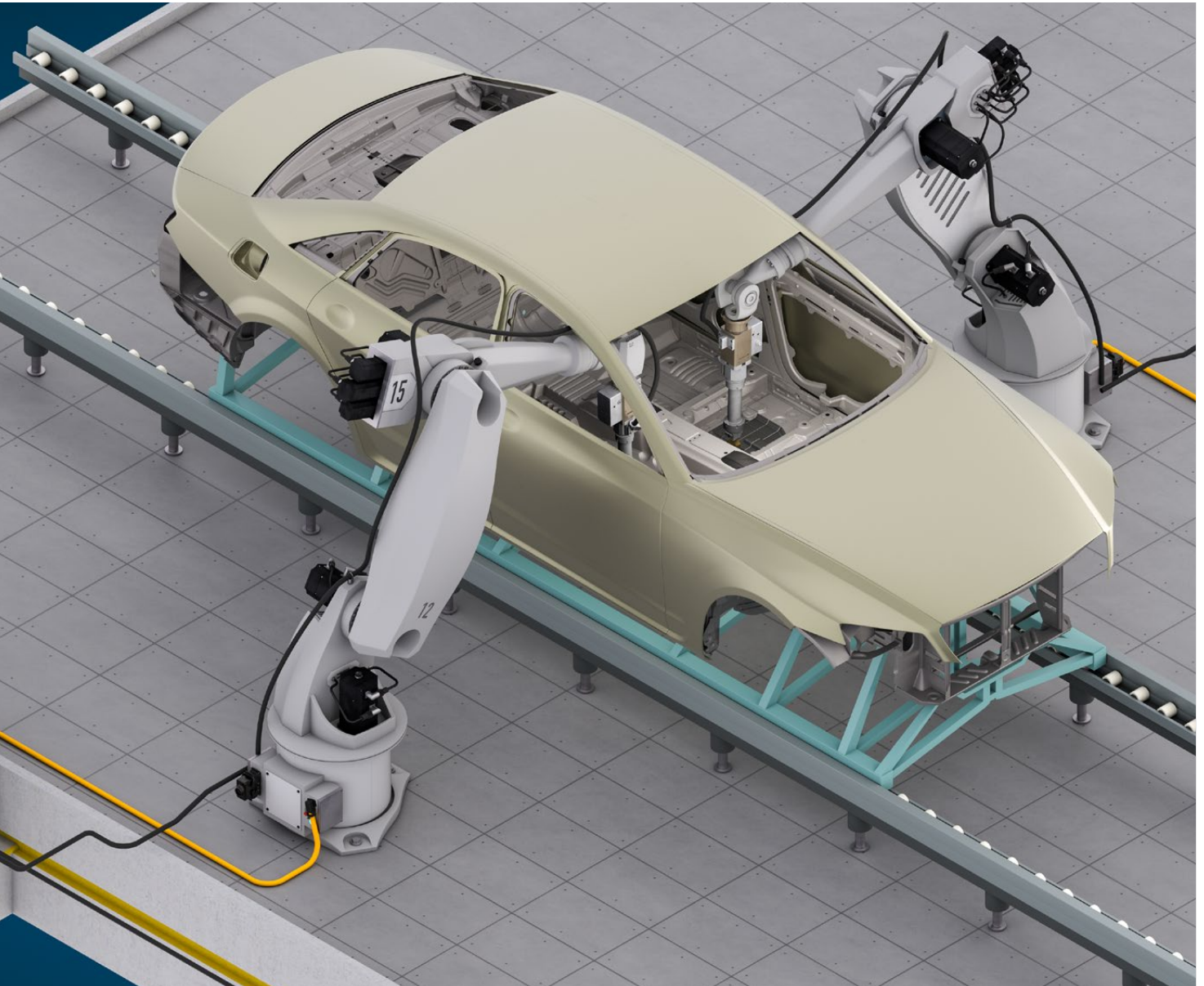

Applicators

For high-quality applications, customers can choose from a variety of [rotatable, multi-nozzle applicators](#). A re-circulation system to the nozzle is usually integrated to stabilize application conditions due to the material properties. The applicator is also [optimized for highly abrasive material](#).



Nozzles

To achieve customer requirements in bead size, a broad range of [standard and customized nozzles is available](#).

Material supply for LASD

Atlas Copco's solution ensures the reliable supply of challenging sound dampening materials.

Atlas Copco invented the UP 1200 to administer the large material volumes required for sound dampening. This displacement pump is characterized by a very high volume flow and high pressure. The robust design of the UP 1200 enables a long lifetime and easy maintenance

When materials are pumped over longer distances, the dynamic pressure decreases which results in insufficient filling pressure at the meter. In order to provide the required pressure, the UP 1200 can also be used as a booster pump.

For LASD, either single barrel pumps or double barrel pumps are used. Ram stations for drums up to 300 gal and 1000l barrels are available.

UP 1200

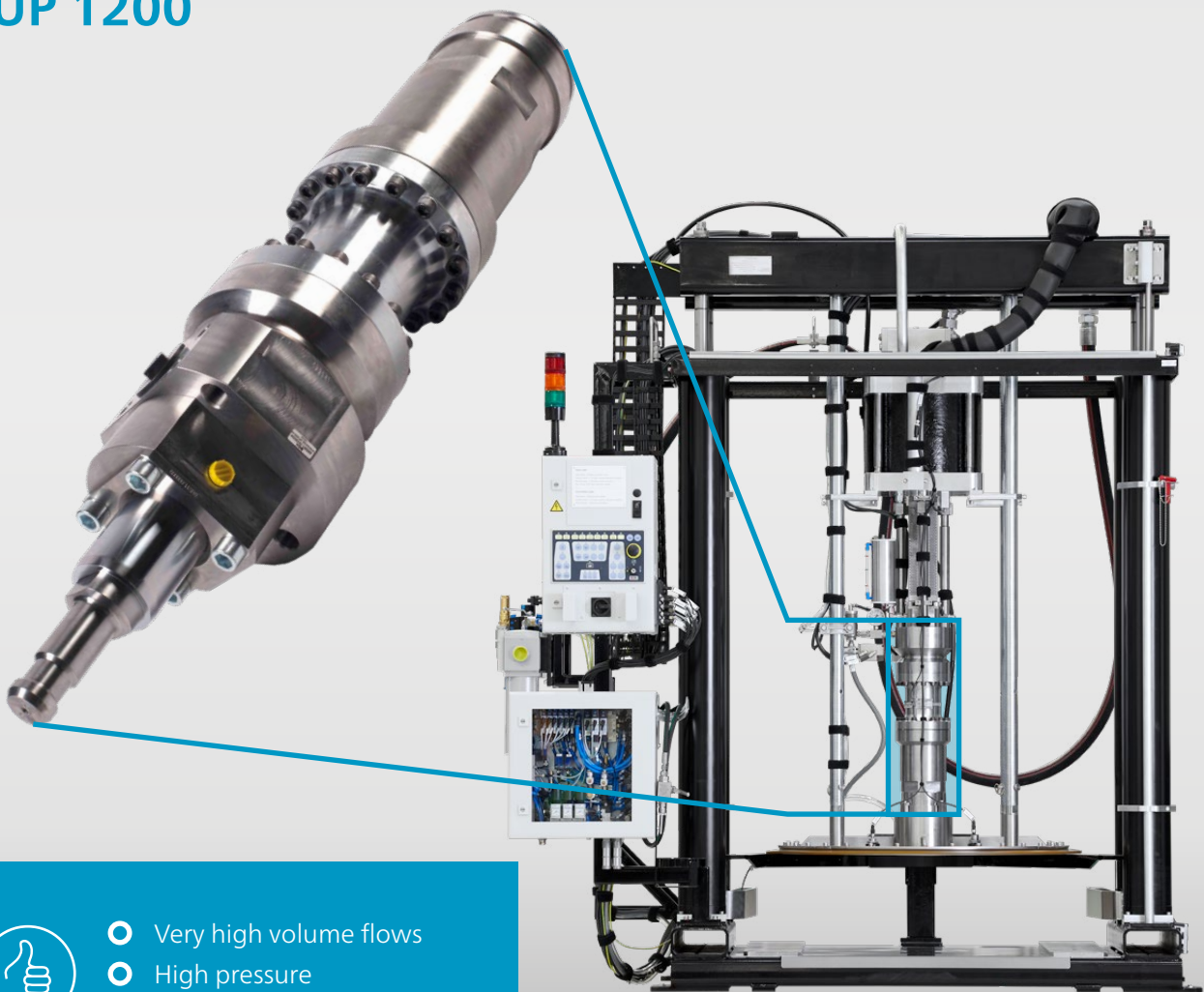

- Very high volume flows
- High pressure
- Robust design

Success story



Initial situation

- Manual insertion of bitumen mats
- High time requirement resulting in long cycle times
- Excessive logistical needs of storing different sizes and shapes of bitumen mats

Atlas Copco solution

- Development of a fully automated application system that withstands highly abrasive materials and fulfills requirements in terms of heating
- Testing and validation of components and material

Situation today

- Usage of Atlas Copco automated application systems for LASD
- Cost effective and space saving: No storage and handling of bitumen mats
- Highly flexible as material can be applied exactly where needed
- Significantly increased productivity and quality
- Reduction of manual work

Contact us!
Learn more about what Atlas Copco
solutions can accomplish
in your paint shop:
sca.info@atlascopco.com

Special application: LASD in white goods industry

Other industries besides the automotive industry are requesting the benefits of automated sound dampening applications.

End users in the appliances or white goods industry place high importance on the energy efficiency, noise damping qualities, and aesthetics of their products.

Liquid sound damping employs a new generation of materials, which can be applied quickly and cleanly using our solutions.

With the advances in insulating materials, process automation has become an attractive option. The cost reductions through reduced labor, fewer quality defects and improved performance are making many producers more competitive in the market.

Stoves, dishwashers, refrigerators and washing machines are examples where Atlas Copco's technology is employed.



LASD application on dishwasher lid



How we innovate our customers

Atlas Copco is synonymous with high quality and efficiency. With operations all over the globe, we have a vital corporate culture that is built on innovation, application knowledge sharing and a strong customer focus.

Individual processes require individual solutions. In our 12 Innovation Centers all around the world, our experienced teams work together with customers and suppliers to develop the best solution for their individual application needs. We strive to be an extension of your innovation department and to offer you the highest value possible.

We keep your systems running

With over 200 service technicians around the world, we are close by and ready to ensure customers get the very most from their Atlas Copco systems, now and for many years to come.



Learn more on how we solve your joining challenge



- Reduction of costs and risks associated with production ramp-up
- Process optimization without disrupting series production
- We connect customers, process experts and material suppliers
- Access to Atlas Copco's process and information database
- Close proximity to customers around the world through 12 global Innovation Centers
- Process development based on customers' actual, real-life processes

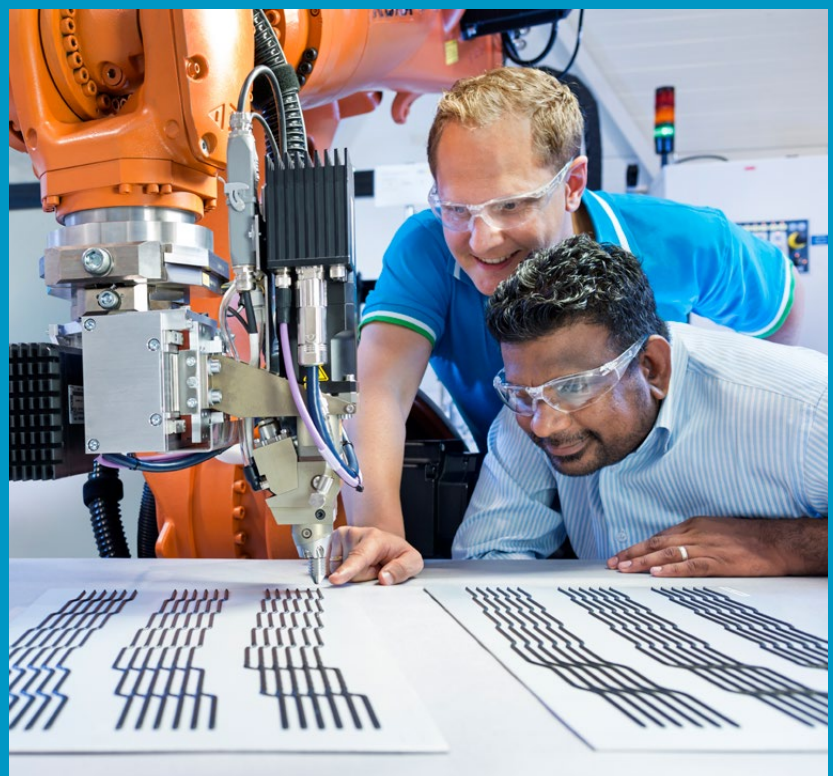



Atlas Copco
Industrial Assembly Solutions
atlas copco.com

